



# LINER TECHNICAL INFORMATION



SIMPLICITY · PERFORMANCE · STYLE

## FRAME LINER

see page 02

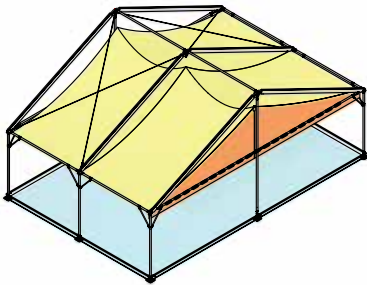

## STRUCTURE LINER

see page 03

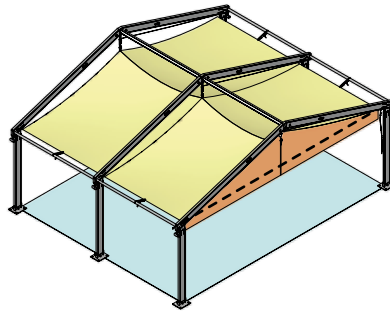

## POLE TENT LINER

see page 04

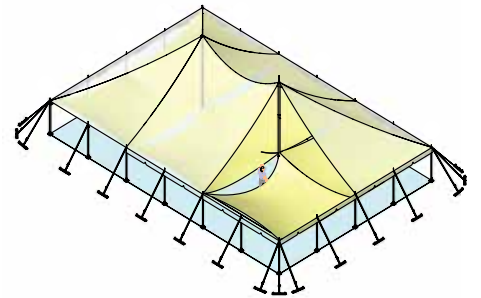

## FLYING CENTRE POLE

see page 05

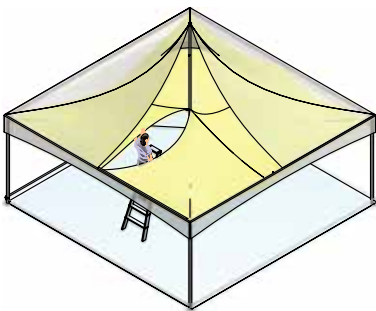

## WALL LINERS & LEG DRAPES

see page 06

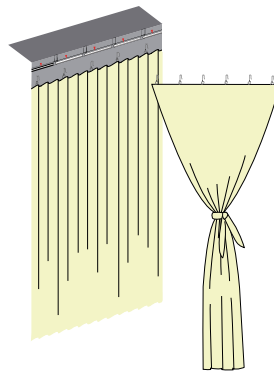

## MOD LINER

see page 07

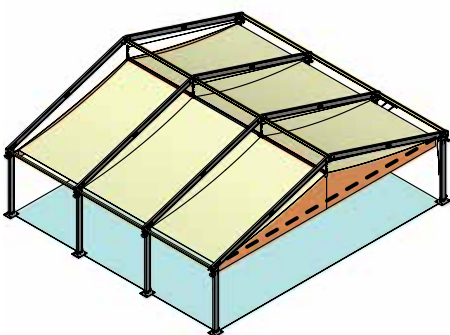

## TRACK LINER

see page 08

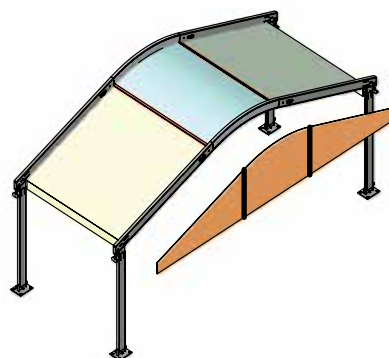

# WHY PURCHASE A LINER?

Baytex Liners help WOW your customers with a stunning, glamorous or fun atmosphere!

- Beautiful for weddings
- Linings add style to functions & events
- Transform commercial interiors or corporate suites

- Inherent flame retardant fabric
- Easy to install
- Excellent monetary return
- Great backup service
- Precisely designed and meticulously manufactured to fit and hang perfectly

For Fabric information and Lining Terminology see pages 09 | 10

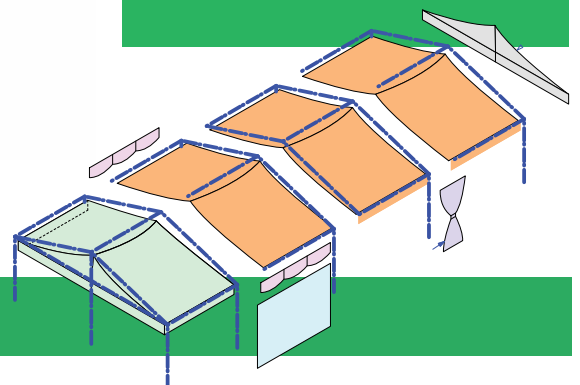

# FRAME LINER

## FRAME BRAND NAME

2" Western Frame System / Twin Tube / Scissor Truss / other

Width x Length (see diagram below)

Width 3m-15m (10'-50')

- 3m Bays (10')
- 4.5m Bays (15')
- 6m Bays (20')

- Gable End
- Hip End
- Scissor Truss
- other

- Gable End Starters (joined to first mid section)
- Gable Ends (separate gable ends)

Do they want Wall Liners or Leg Drapes

- what is the leg height

- Gathered/Pleated - Silkline 75d (2oz)
- Flat/Smooth - Silkline 300d (6oz)

- White • Champagne • Black

## Basic Installation Information

For full Installation Instructions contact Baytex

Attach halyard pulley to apex fitting using shackle

... or apex purlin using web loop

NB attach to frame before standing portal or use ladder after

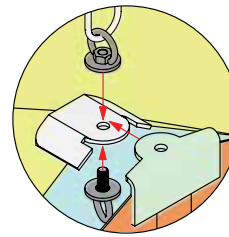
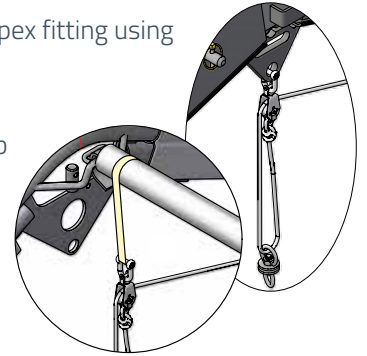

At gable & mid velcro joins connect apex patches to lifting rings

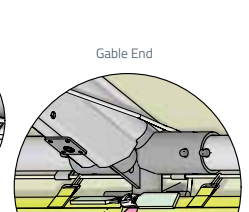
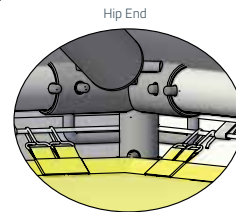

Attach liner hooks to eave cord at each leg, velcro panels together

Fasten gable corner strap to leg and thread through cambuckle, velcro panels

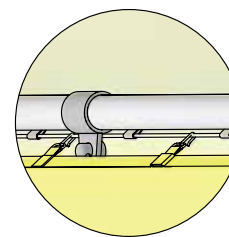
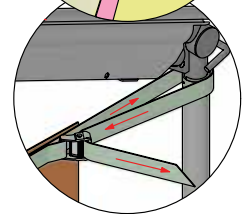

Attach remaining liner hooks to eave cord, raise liner to finished height

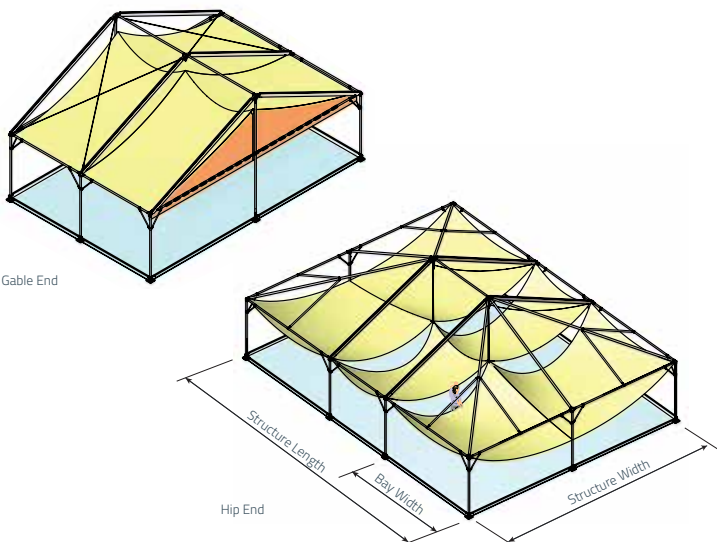

Frame Liner - Gathered / White



# STRUCTURE LINER

## STRUCTURE BRAND NAME

Hocker / Roder / Losberger / Anchor / Aztec / other

Width x Length (see diagram below)  
eg 10mx30m (33'x60') in either

- 3m Bays (10') P1 Series
- 5m Bays (16') P2 Series

- Gable End
- Hip End
- other

- Gable End Starters  
(joined to first mid section)
- Gable Ends  
(separate gable ends)

Do they want Wall Liners  
or Leg Drapes

- what is the leg height

- Gathered/Pleated - Silklite 75d (2oz)
- Flat/Smooth - Silklite 300d (6oz)

- White • Champagne • Black

## Basic Installation Information

For full Installation Instructions contact Baytex

Attach halyard pulley to apex fitting  
using shackle

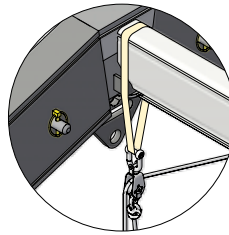

... or apex purlin  
using web loop

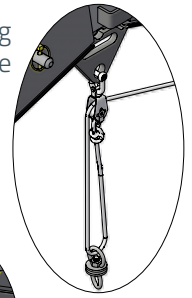
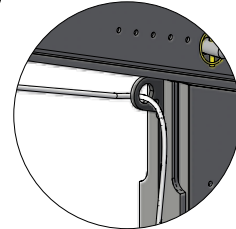

Thread pulley  
rope through  
knee fitting

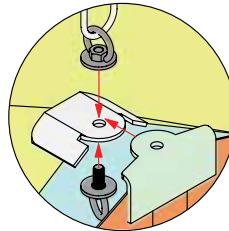

At gable & mid panel velcro joins  
connect apex patches to lifting ring

Connect sister clips,  
pull liner to eave and attach  
bungy hook to frame,  
velcro panels together

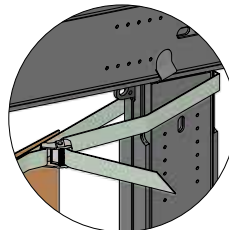

Fasten corner strap to leg and  
thread through cambuckle, velcro  
panels

P1 Series: Attach side  
release buckle to eave rail  
and tension

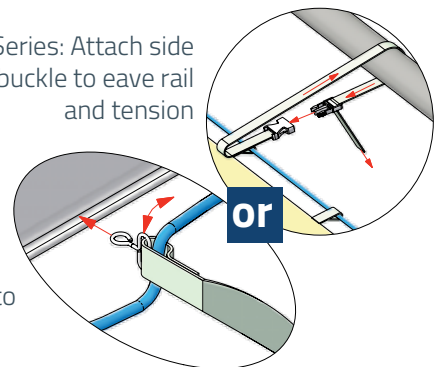

P2 Series: Attach  
remaining liner  
hooks to eaves ie  
around eave or into  
keder groove

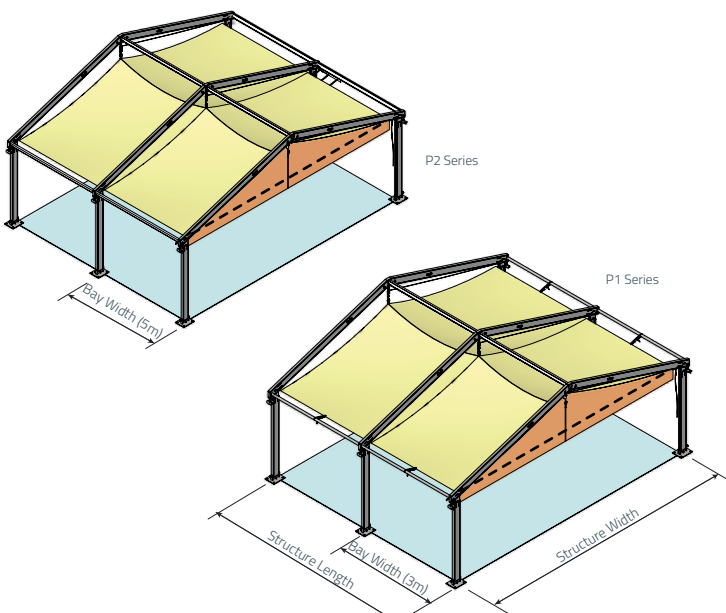
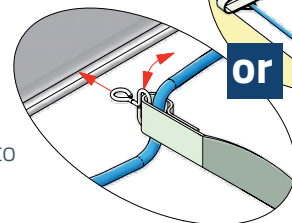

Structure Liner - P2 / Flat / White

# POLE TENT LINER

## POLE TENT BRAND NAME

Anchor / Aztec / Electron / Toptec Sierra / Eureka / Genesis / other

## Width x Length

eg • 6m (20') • 9m (30') • 12m (40')  
• 15m (50') • 18m (60') • 24m (80') • 30m (100')

## Poles

- Single Row
- Multi Row

Do they want Wall Liners or Leg Drapes

- what is the leg height

Do they want Center Pole Drapes

- what is the pole height

- Gathered/Pleated - Silcline 75d (2oz)
- Flat/Smooth - Silcline 300d (6oz)

- White • Champagne • Black

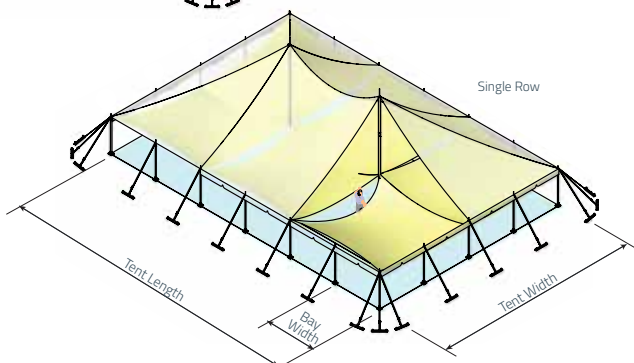
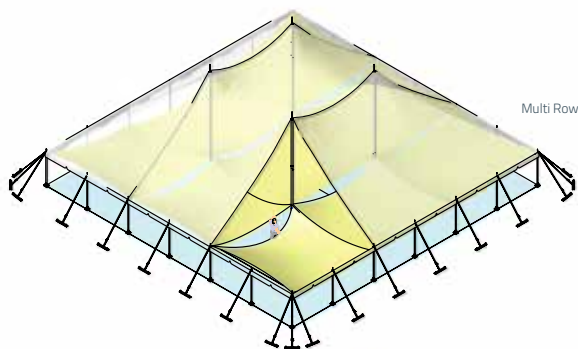

## Basic Installation Information

For full Installation Instructions contact Baytex

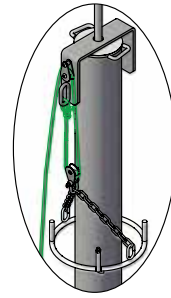

Attach pole saddle on main tent pole top prior to installing PVC roof, lower bail ring to working height approx 1.8m (6') off ground

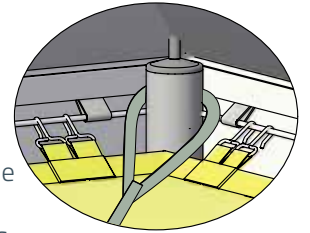

Connect corner liner hooks to eave cord on PVC roof each side of corner pole NB corners first, then panel joins and mid points, lastly pole spacings. Use web loop to pull corner to leg if required.

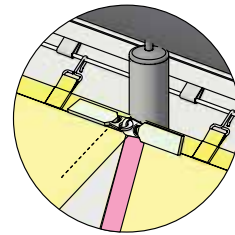

Attach liner panel to bail ring pins, connect sister clips

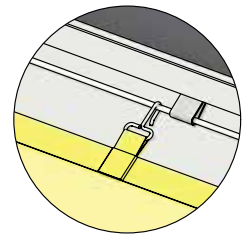

Attach all remaining liner hooks, use halyard cord to raise bail rings to finished height

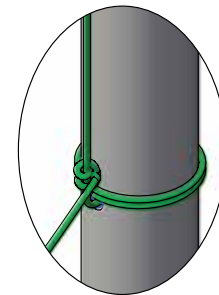

Tie off halyard cord on centre pole



Pole Tent - Gathered / White

# FLYING CENTRE POLE / FETE

## TENT BRAND NAME

Fete / Springtop / Flying Centre Pole / other

Width x Length

eg • 3m (10') • 4m (13') • 5m (16') • 6m (20')  
or multiples of

- Single Peak
- Double Peak

Do they want Wall Liners  
or Leg Drapes

- what is the leg height

- Gathered/Pleated - Silcline 75d (2oz)
- Flat/Smooth - Silcline 300d (6oz)

- White • Champagne • Black

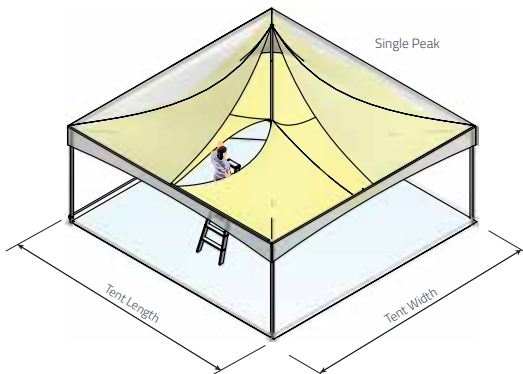
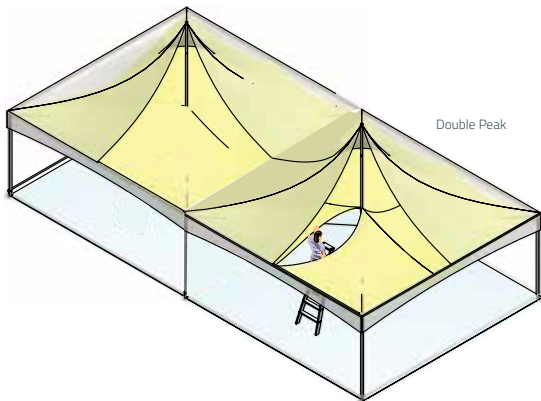

## Basic Installation Information

For full Installation Instructions contact Baytex

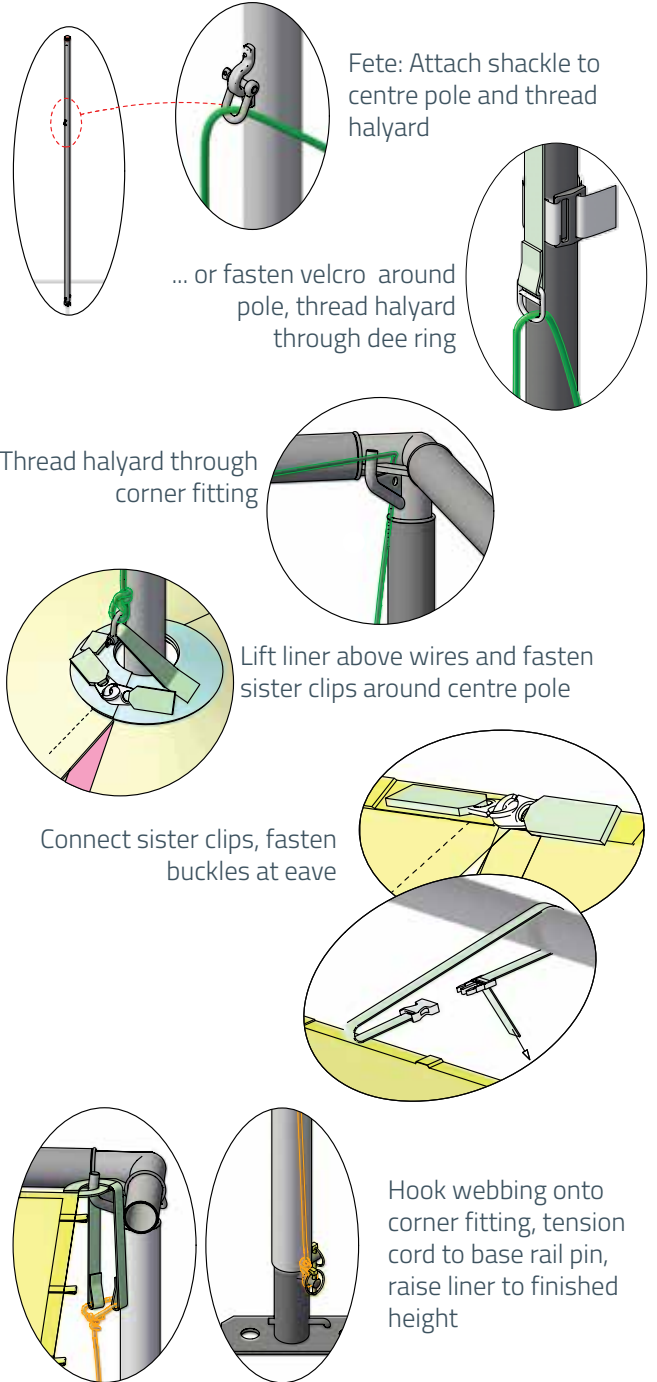

Flying Centre Pole Roof Liner with Leg Drapes - Gathered / White

# WALL LINERS & LEG DRAPES

**BRAND NAME**  
 Frame, Structure, Pole, Flying Centre Pole, MOD, Track

## WALL LINERS

## LEG DRAPES

Leg Height  
 ie 2.1m (7'), 2.4m (8'),  
 3m (10') etc

Leg Height  
 ie 2.1m (7'), 2.4m (8'),  
 3m (10') etc

- Velcro joins
- Pocket

- Gathered/Pleated - Silkline 75d (2oz)
- Flat/Smooth - Silkline 300d (6oz)

- White • Champagne • Black

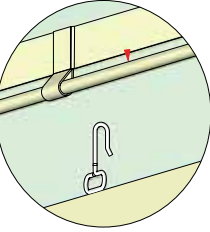

Wall Liners: attach wall liner hooks to interior roof rope



Wall Liners - Gathered / White

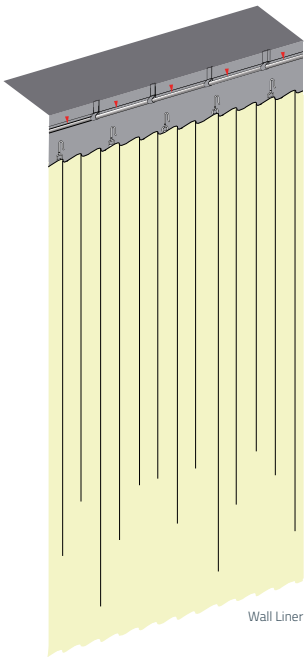

Wall Liner

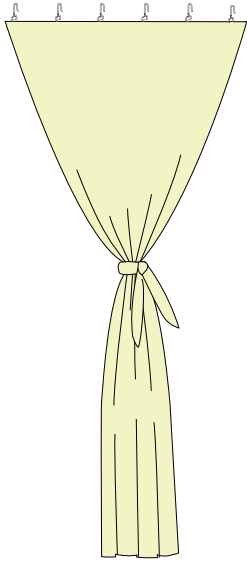

Leg Drape



Leg Drapes - Gathered / White



# MOD LINER

(Multi-use and extendable in width & length)

## STRUCTURE BRAND NAME

Hocker / Roder / Losberger / Anchor / Aztec / other

Width x Length

- 5m Bays (16')

- Gable End
- Hip End

Do they want Wall Liners or Leg Drapes

- what is the leg height

Hardware

- Single Rail
- Twin Rail
- Triple Rail

- Gathered/Pleated - Silkline 75d (2oz)
- Flat/Smooth - Silkline 300d (6oz)

- White • Champagne • Black

## Basic Installation Information

For full Installation Instructions contact Baytex

Attach halyard pulley to apex fitting using shackle

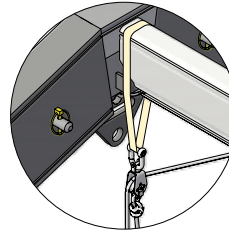

... or apex purlin using web loop

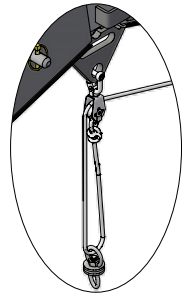

Thread pulley through knee fitting

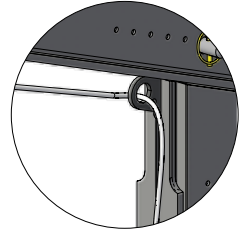

Connect sister clips, pull liner to eave and attach bungy hook to frame, velcro panels together

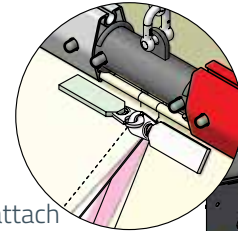

Fasten corner strap to leg and thread through cambuckle, velcro panels

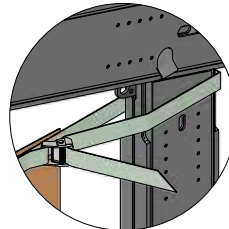

Attach remaining liner hooks to eaves ie around eave or into keder groove

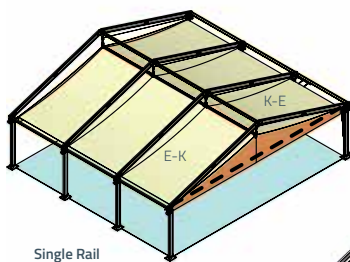
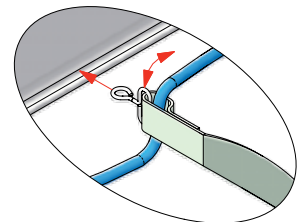

Single Rail

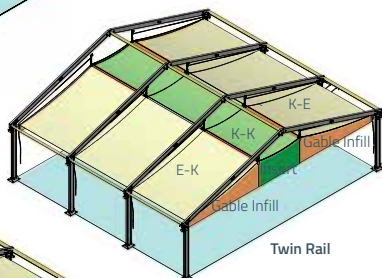

Twin Rail

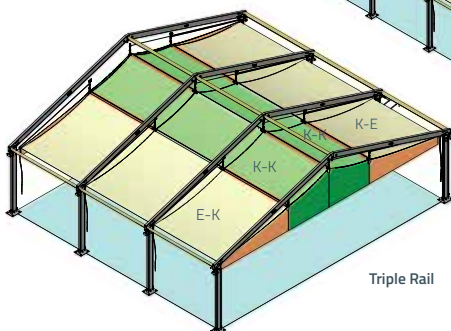

Triple Rail



Mod Liner / Flat / White



# TRACK LINER

(using 4 Track Rafter)

## STRUCTURE BRAND NAME

Hocker / Roder / Losberger / Anchor / Aztec / other

### Width x Length

- 3m Bays (10') with 4-track only
- 5m Bays (16')

- Gable End
- other

- A-Frame
- Curved Top (Arcum)
- Arched Top

Do they want Wall Liners or Leg Drapes

- what is the leg height

- Flat/Smooth - Silcline 300d (6oz)

- White • Champagne • Black

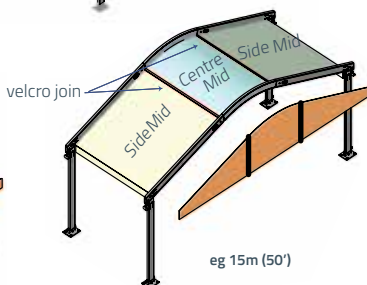
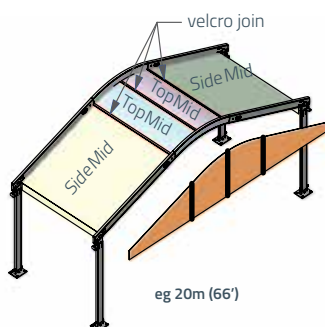
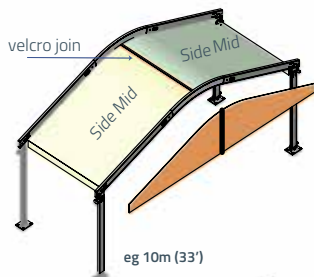

## Basic Installation Information

For full Installation Instructions contact Baytex

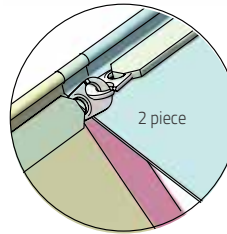
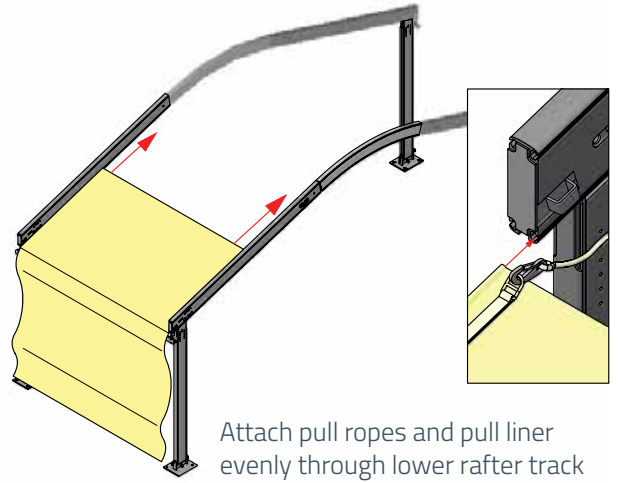

Gables tensioned at eave level with camlock buckle and web strap

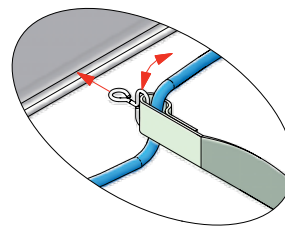
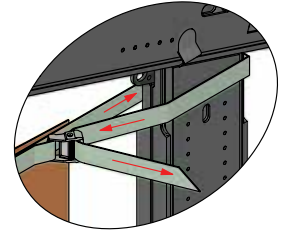

Attach hooks at end of bungy

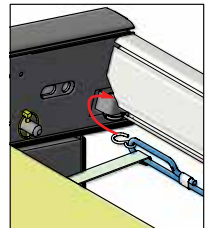

Arched Track Liner / White

## FABRIC INFORMATION

Baytex Silklane Liners are manufactured from 100% polyester fibre for maximum durability and easy care. All Baytex Silklane fabrics are inherently flame retardant, they have a soft finish with a beautiful silky sheen that resists hard creasing.

### FABRIC CARE INSTRUCTIONS

Silklane is an inherently flame retardant 100% polyester fabric.

It can be washed any number of times with no deterioration of the fabric's flame retardant performance. Silklane has no chemical treatment to wash out.

#### Follow these simple instructions for a long lasting performance:

- Treat Silklane as a delicate fabric
- Launder in a domestic or commercial washing machine
- **Only** use cool water and a mild laundry detergent
- Fluff dry thoroughly using cool or warm air only (max 50°C/120°F)
- Restuff into storage bags when completely dry
- Never store liners damp
- Spot clean bad marks only as necessary
- Use a fabric steamer or warm iron for smooth wrinkle appearance

Important:

Always avoid excessive heat as this may damage or shrink the fabric.

#### Fabric Type:

- FR300 (6oz) - For Flat Linings
- FR75 (2oz) - For Gathered Linings

#### Colour Options



#### Fabric Qualities



### FLAME RETARDANCY CERTIFICATION

All Silklane Plus fabrics are inherently flame retardant and comply with the following International Flame Retardancy Standards:

- Europe: Classification: M1 Durability of Classification: (NF P 92-512 : 1986)
- UK: BS 5867 Pt2 Type B
- Germany: DIN 4102-1 and NTA 8007:2007 'Brandgedrag von verseiringsmaterialien' classification 'B'
- USA: NFPA 701 small scale / USA CalifoWW7101
- Australia & NZ: AS1530: Pts 2 & 3

Full reports and certifications are available to Baytex customers upon request.

## BAG LINERS

Baytex Liners are supplied in labelled, colour coded Carry Bags for the complete package



# LINING TERMINOLOGY

- A1 Gable End Starter
- A2 Gable Infill - on piece
- B Mid
- C Detachable Valance Swag (optional extra)
- D Wall
- E Leg Drape

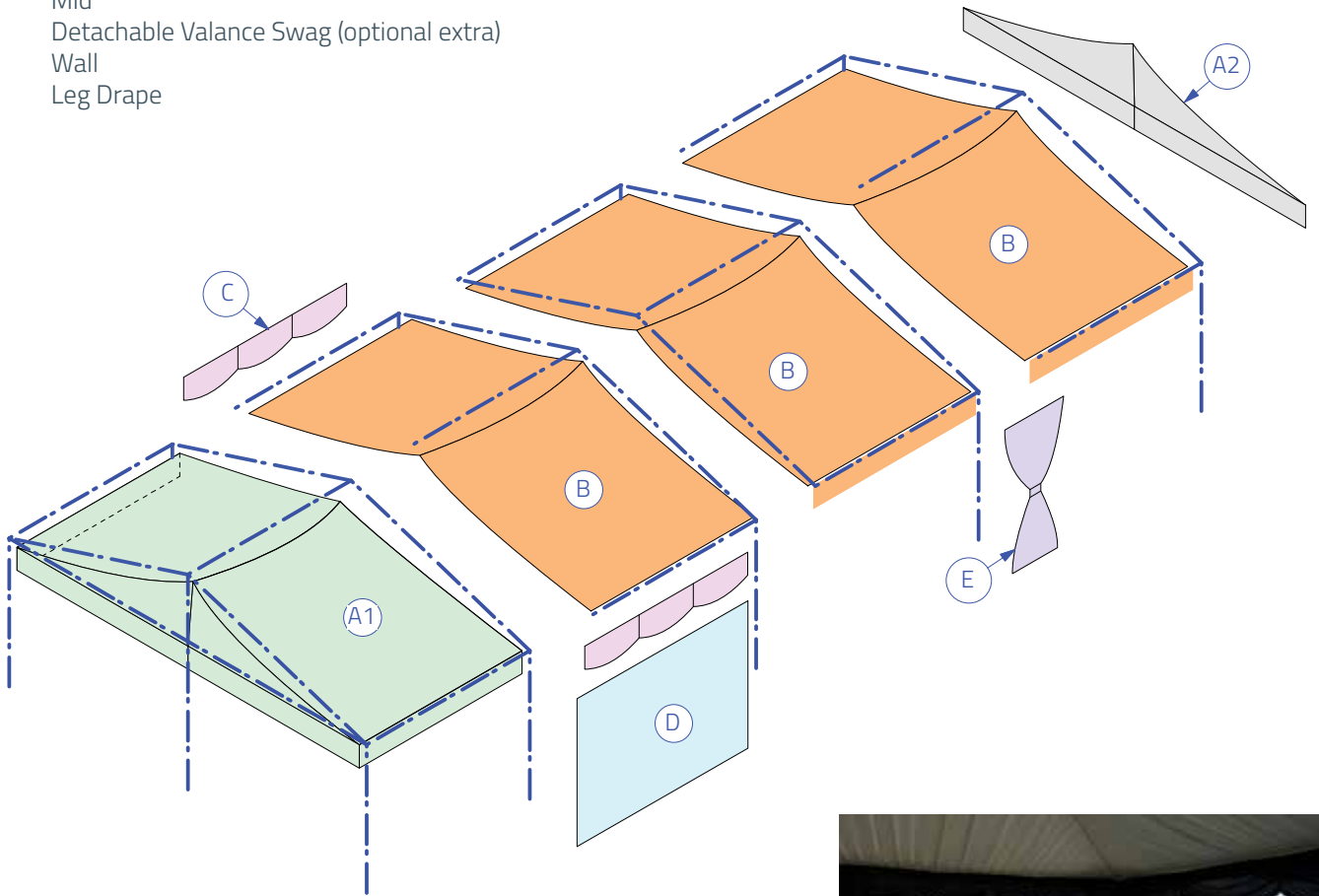

C Detachable Valance Swag (optional extra)

# USEFUL FRAME DIMENSIONS

Often we will ask you for dimensions to confirm lining size, or in the case of a custom liner.

If you also require wall liners please supply the leg height.

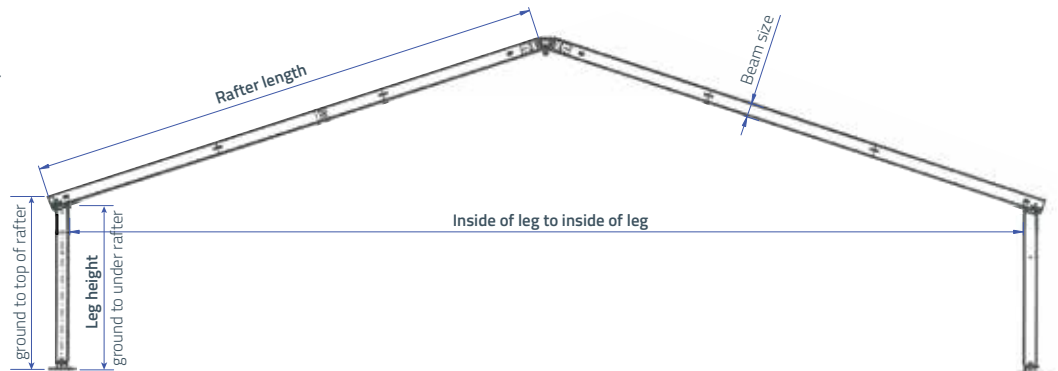





SIMPLICITY · PERFORMANCE · STYLE

**New Zealand**

52 Newton Street,  
PO Box 4370, Mount Maunganui  
New Zealand

tel +64 7 579 0190  
fax +64 7 579 0194  
www.baytex.co.nz

**Australia**

tel 1800 766 661  
www.baytex.com.au  
info@baytex.com.au

